

酸化防止剤  
Antioxidants

A970526C

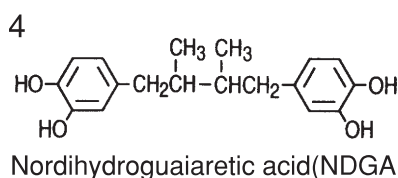
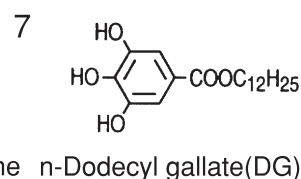
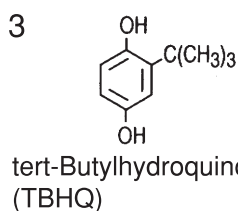
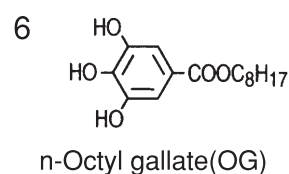
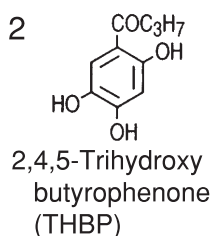
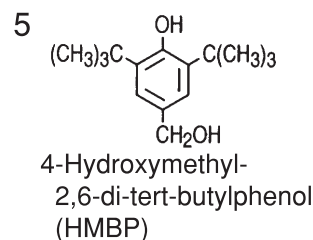
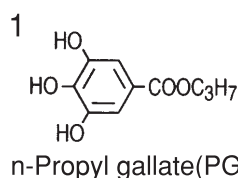
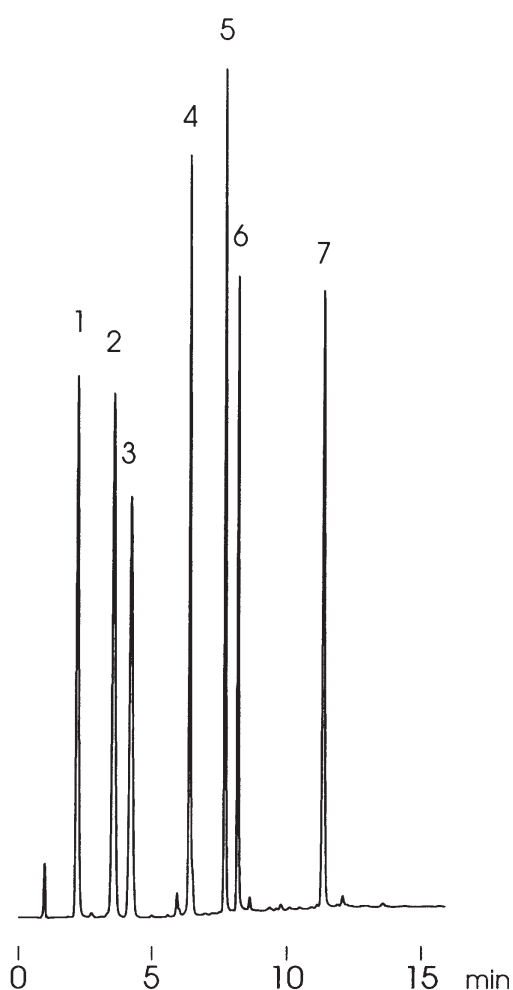

Column	: YMC-Pack Pro C18 (5 μm, 12nm) 75 × 4.6 mm I.D.
Eluent	: A)acetonitrile/methanol/5% acetic acid (20/20/60) B)acetonitrile/methanol/5% acetic acid (45/45/10) 0-100%B (0-10min), 100%B (10-20min)
Flow rate	: 1.0 mL/min
Temperature	: 30 °C
Detection	: UV at 280 nm, 0.32 AUFS
Injection	: 9 μL (0.05~0.6 mg/mL)